

SureLock™ ROUSB Laser Diode Module

Operator's Manual

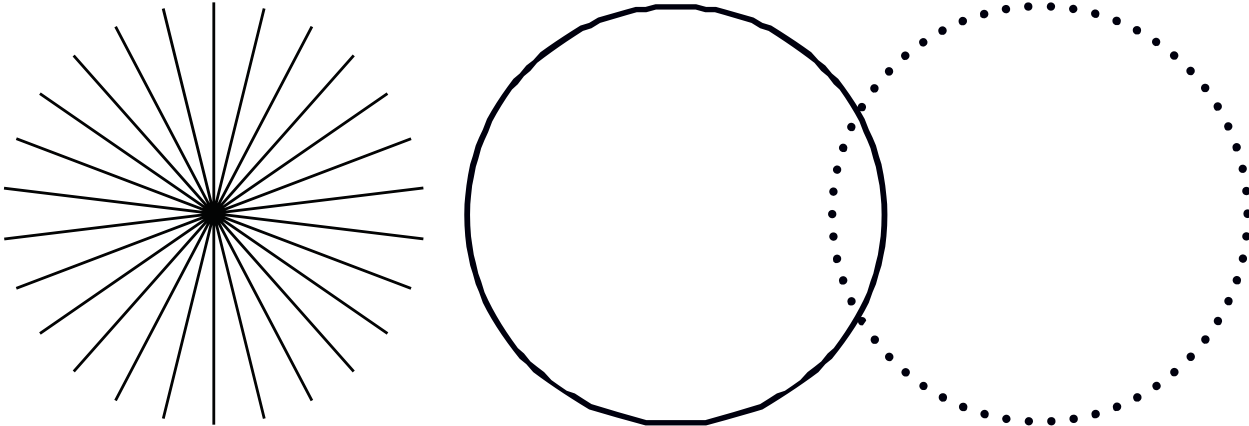

This document is copyrighted with All Rights Reserved. Under copyright laws, this document must not be copied in full or in part, or reproduced by any other media, without the express written permission of Coherent, Inc. (Coherent). Permitted copies must have the same proprietary and copyright notices as were attached to the original. This exception does not permit copies—whether or not sold—to be made for others; however, all the material purchased can be sold, given, or loaned to another person. Under the law, “copying” includes translation into another language.

Coherent, the Coherent Logo, and the SureLock Compact Laser are registered trademarks of Coherent, Inc. All other trademarks or registered trademarks are the property of their respective owners.

Patents referenced in this manual are active when the manual is printed (see last page for the date). You are advised to check if the patents are still active www.coherent.com/legal/patents.

Every effort was made to make sure that the data shown in this document is accurate. The information, figures, tables, specifications, part numbers, and schematics contained in this manual are subject to change without notice. Coherent makes no warranty or representation, either expressed or implied, related to this document. In no event will Coherent be liable for any direct, indirect, special, incidental, or consequential damages caused by any defects in its documentation.

Technical Support

In the U.S.:

Should you experience any difficulties with your laser or need any technical information, please go to our web site www.Coherent.com. Should you need further assistance, please contact Coherent Technical Support by e-mail customer.support@coherent.com or telephone, +1-734-456-3100. Please be prepared to supply the model and laser head serial number of your laser system, the description of the problem, and any attempted corrective steps to the Product Support Engineer responding to your request.

Telephone coverage is available Monday through Friday (except U.S. holidays and company shutdowns). Inquiries received outside of normal office hours will be captured by our automatic answering system and will be quickly returned the next business day.

Outside the U.S.:

If you are located outside the U.S., please visit www.Coherent.com for technical assistance, or contact your local Service Representative. Service Representative telephone numbers and addresses can be found on the Coherent web site.

Coherent provides telephone and web-based technical assistance as a service to its customers and assumes no liability for any injury or damage that can occur at the same time with such services. Under no conditions do these support services affect the terms of any warranty agreement between Coherent and the buyer. Operation of any Coherent laser with any of its interlocks defeated is always at the operator's own risk.

TABLE OF CONTENTS

1	Safety Precautions	6
1.1	Export Control Laws Compliance	6
1.2	Explanation of Warning Symbols.....	6
1.3	Signal Words	6
1.4	Symbols	7
2	Laser and Operational Safety Precautions	7
2.1	Safety Features For Compliance	7
2.2	Laser Feedback Warning.....	8
2.3	Units With Fiber	9
2.4	Summary of Precautions	10
3	Applications and Features	10
3.1	Applications.....	10
3.2	Standard Features	10
4	Specifications	10
4.1	Specifications.....	10
4.2	Mechanical Dimensions.....	11
4.2.1	Standard Configuration	11
4.2.2	Isolator Configuration	11
4.2.3	Fiber Pigtail Configuration	12
5	Operating Procedures	12
5.1	Standard CW Operation	12
5.1.1	User Startup Procedure:.....	12
5.1.2	Laser Module Startup Process:.....	13
5.2	Operation via USB Communications Port	13
5.2.1	Baud rates and serial port settings.....	13
5.2.2	Command formatting and termination characters.....	13
5.2.3	Handshaking.....	14
5.2.4	Commands	14
5.3	Remote Key Switch Operation (Required for non-OEM Customers)	15
6	Maintenance	15
6.1	Maintenance and Inspection.....	15
7	Service And Warranty	15
7.1	Repair	15

7.2	For Information or Enquiries	16
7.3	Coherent Limited Warranty	16
7.4	Contacting Coherent	18
8	Appendix	18
8.1	Sample communication setup using Putty	18
9	Fiber Cleaning	23
9.1	Importance Of Maintaining Clean Fiber-Connections	23
9.2	Cleaning the Fiber Connector	24
9.3	Inspecting And Cleaning Delivery-Fiber Ends	24

1 Safety Precautions

This instruction manual explains how to use the Coherent Surelock™ RO USB Laser Diode Module.

Before use, please read this manual thoroughly. After reading, keep it together with the product for reference when necessary. Please retain all original packaging material in the event the unit is stored or shipped in the future.

For non-OEM applications, we recommend following safety protocols for Class 3B products according to latest ANSI Z136.1 Standard for the Safe Use of Lasers.

Use protective eyewear to eliminate potential eye exposure in excess of the maximum permissible exposure levels as stated in either ANSI Z136.1 or IEC-60825-1



CAUTION – *Use of controls or adjustments or performance of procedures other than those specified herein may result in hazardous radiation exposure. Body of the unit contains labels specifying wavelength and maximum emitted power.*

1.1 Export Control Laws Compliance

It is the policy of Coherent to strictly comply with U.S. export control laws.

Export and re-export of lasers manufactured by Coherent are subject to U.S. Export Administration Regulations, which are administered by the Commerce Department. In addition, shipments of certain components are regulated by the State Department under the International Traffic in Arms Regulations.

The applicable restrictions vary depending on the specific product involved and its destination. In some cases, U.S. law requires that U.S. Government approval be obtained prior to resale, export or re-export of certain articles. When there is uncertainty about the obligations imposed by U.S. law, clarification must be obtained from Coherent or an appropriate U.S. Government agency.

Products manufactured in the European Union, Singapore, Malaysia, Thailand: These commodities, technology, or software are subject to local export regulations and local laws. Diversion contrary to local law is prohibited. The use, sale, re-export, or re-transfer directly or indirectly in any prohibited activities are strictly prohibited

1.2 Explanation of Warning Symbols

This documentation may contain sections in which particular hazards are defined or special attention is drawn to particular conditions. These sections are indicated with signal words in accordance with ANSI Z-535.6 and safety symbols (pictorial hazard alerts) in accordance with ANSI Z-535.3 and ISO 7010.

Warning messages are intended to prevent accidents to operating personnel such as burns and electrical shocks.

1.3 Signal Words

Three signal words with color coded call-outs are used in this documentation:

WARNING!, **CAUTION**, and **NOTICE**.

The signal words **WARNING** and **CAUTION** designate the degree or level of a hazard when there is a risk of user injury:

WARNING!

Indicates a hazardous situation that, if not avoided, could result in serious injury to eyes and/or skin.

CAUTION

Indicates a hazardous situation that, if not avoided, could result in minor to moderate injury to eyes and/or skin.

The signal word **NOTICE** is used when there is the risk of product or property damage:

NOTICE

Indicates information important to take special note of, but is not hazard-related.

1.4 Symbols

The signal words **WARNING**, and **CAUTION** are always emphasized with a safety symbol that indicates a special hazard, regardless of the hazard level:



This symbol is intended to alert the operator to the presence of highly-important operating and maintenance instructions.



This symbol is intended to alert the operator to the danger of exposure to hazardous visible and invisible laser radiation.



This symbol is intended to alert the operator to the danger of Electro-Static Discharge (ESD) susceptibility.



This symbol is intended to alert the operator to the presence of additional important information.

2 Laser and Operational Safety Precautions

2.1 Safety Features For Compliance

This laser system is considered for OEM integration laser system when used without optional keyswitch accessory. When used with the optional keyswitch accessory, the Compact Laser System complies with the United States Code of Federal Regulations (CFR) 21 CFR 1040.10 and 1040.11, except for deviations

pursuant to CDRH (Center for Devices and Radiological Health) Laser Notice 50, dated July 24, 2007. The laser system is harmonized with both CDRH and International Electrotechnical Commission (IEC) 60825-1 standards, as a Class 3B (or, IIIb) laser product, and it may emit Visible or Invisible Laser Radiation in wavelengths from 0.4 to 1.064 μm from the Laser Aperture in the front.

Laser Aperture Laser output location warning

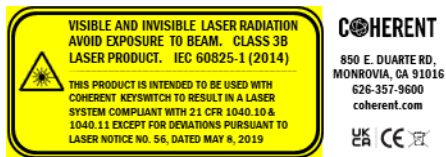

The required Classification, Warning Logotype, Aperture, and Information labels are permanently affixed to (or screen-printed on) the housing, along with the Model Number, a unique Serial Number, Date Manufactured, and the units' maximum Output Power and Wavelength. Additionally, the wavelength is also found in the Model Number.



CAUTION – *CDRH Classification is only applicable when used with optional keyswitch accessory.*

2.2 Laser Feedback Warning

Semi-conductor laser diodes are highly sensitive to optical feedback. They can suffer damage that maybe immediately apparent through loss in power or a reduction in life. Furthermore, wavelength stabilized laser diodes may lose their spectral characteristics such as center wavelength and linewidth if sufficient optical feedback exists.

Your Coherent laser diode does not incorporate an optical isolator, so may be susceptible to extraneous optical feedback. We recommend the following precautions:

- If the output of the laser diode is collimated, all reflective surfaces in the optical path should be angled so that surface reflections would not be reflected back to the laser diode. Furthermore, since optimal alignment for interferometric measurement instruments is often achieved with the instrumentation optics at normal incidence to the laser, we recommend the use of optical isolators or slightly misaligning the instrument to avoid direct feedback into the laser.
- Beware of focusing the light output on a highly reflective/scattering surface. This is another means of generating high optical feedback to the diode.
- If fiber coupling, anti-reflective (AR) coated tips are recommended for multimode (MM) fiber. Angle polished tips and AR coating are recommended for single mode (SM) fiber.
- Beware of wavelength selective filters with narrow wavelength pass bands. Care should be taken not to align at normal incidence to the beam. Furthermore, be careful not to align the reflected light to be normal incidence during the alignment process (e.g. sweeping the beam back across the laser during alignment). If such a possibility is unavoidable, use a sufficient OD filter (or isolator) at the output of the laser diode during the alignment process. Please

note that if sufficient additional feedback reaches the laser diode, it would overcome the grating-induced stabilization, unlocking and shifting the wavelength of the laser beyond the pass band of the filter. This will dramatically increase the reflected intensity back into the laser possibly causing damage.

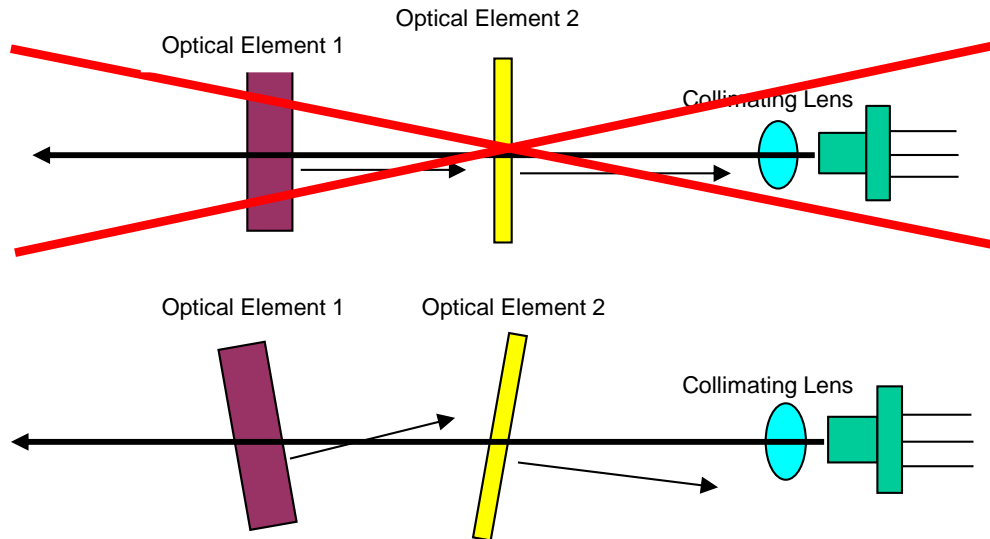

WARNING - Laser lifetime may be adversely affected with optical feedback. Momentary strikes on the scale of sub seconds are sufficient to cause permanent damage which could manifest later in diode lifetime.

2.3 Units With Fiber

Units with fiber have special consideration:

- Fiber tips are susceptible to damage due to cleanliness. Output light from fiber tip facet attracts dust and debris when exposed to the environment. Clean and inspect fiber tips before mating. Damage could occur when mating dirty fiber tips.
- Review appendix for possible fiber cleaning solutions.
- Fiber has a minimum bend radius, typically 20mm. Do not bend fiber below 20 mm.
- Do not pull-on fiber. Handle fiber gently and with care.



Damaged fiber tips and fiber due to mishandling or cleanliness are not covered by warranty. Certain types of damage are not repairable.

2.4 Summary of Precautions



To prevent permanent damage, observe these precautions:

1. **Protect against electrostatic discharge.**
2. **Mount laser to a suitable thermal heatsink**
3. **Use supplied power supply or power supply meeting specifications.**
4. **Do not drop the module or operate it at extreme temperatures or humidity.**
5. **Beware of optical feedback from reflective surfaces. Permanent damage to the laser diode is possible.**
6. **Inspect and clean all fiber tips before use and mate.**

3 Applications and Features

3.1 Applications

This device is a compact laser diode module with integrated laser diode current driver and temperature control for high precision equipment and instrumentation. It plays a pivotal role in testing or manufacturing, and can be used in various applications such as Flow Cytometry, Confocal Microscopy, Protein Crystallography, DNA Sequencing, Semiconductor Defect Detection, Thin Film Analysis, High Density Data Storage, and Raman Spectroscopy.

3.2 Standard Features

- Plug & Play Operation
- ESD Protection
- Constant Current Driver
- Adjustable Output Power
- Adjustable Temperature Setpoint
- Remote Key Switch with Remote Interlock (Optional for OEM customers)
- Remote Computer Control Capability
- Temperature Stabilized
- Compact Size

4 Specifications

4.1 Specifications

OPTICAL	
(See Datasheets for reference)	
ELECTRICAL	
Operating Voltage	3.3V DC 3.3V - 5V DC [for units accompanied with 5V power supplies]
Operating Current	0.5 A max / 3 A for >300mW Modules
MECHANICAL	

Laser Dimension	25.4 mm x 76.2 mm (configuration dependent)
Weight	< 1 lb
Operating Temperature	+10°C to +40°C
Storage Temperature	-40°C to +80°C

4.2 Mechanical Dimensions



4.2.1 Standard Configuration

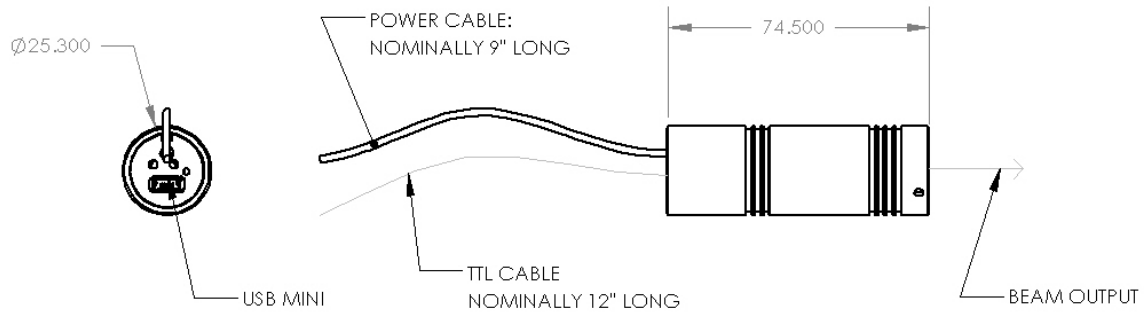

4.2.2 Isolator Configuration

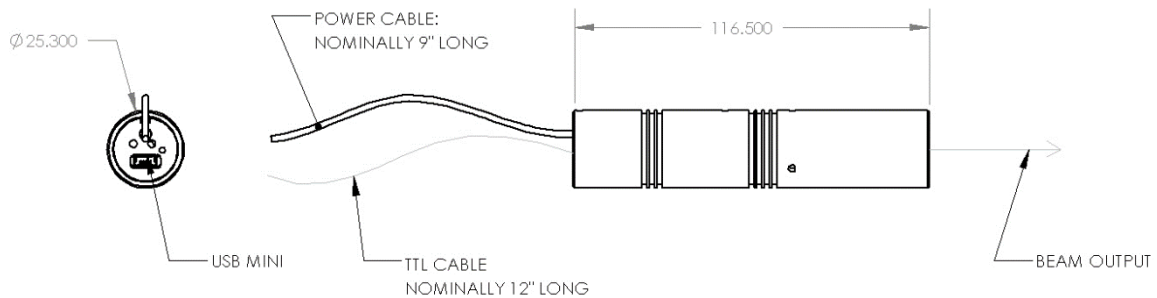

4.2.3 Fiber Pigtail Configuration

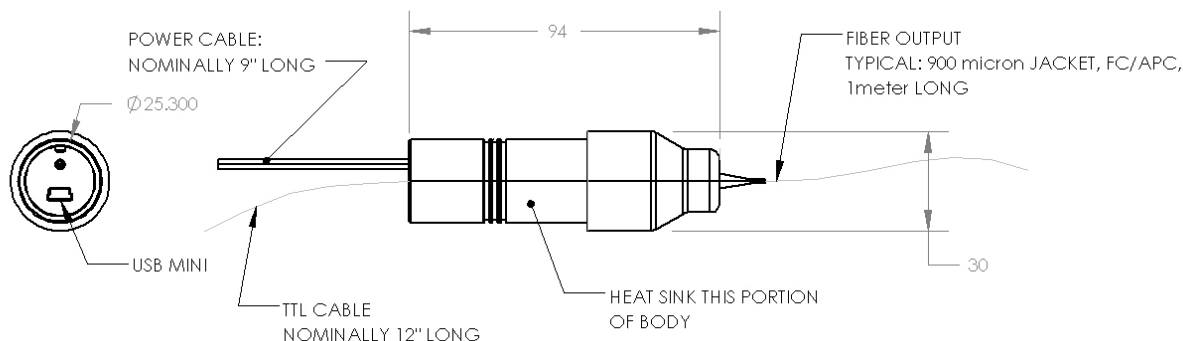

Supplied with leads for TTL laser on/off (connector: DF13-2S-1.25C):

Default Open: Laser On

To Turn Laser Off: Connect TTL, white wire, to ground, black wire

2.1 x 5.5mm Center Positive Standard Jack for supplying operating voltage and current. Transient 100% voltage input drop off per IEC 61326-1:2020 may cause unit to shut down and return back to its default power on operating condition.

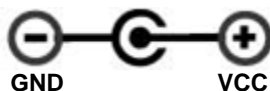

Figure 4.2-1 – Electrical Connections

Status LED:	Meaning
Fast flashing (150 ms on / 150 ms off)	Waiting for temperature to be stable after power on
Slow flashing (300 ms on / 300 ms off)	Waiting for 20 seconds
Flash 1 time (200 ms on) every 2 s	Running normally

5 Operating Procedures

5.1 Standard CW Operation

Laser module can be operated with or without USB communication port.

5.1.1 User Startup Procedure:

- Properly mount laser module on a heat sink.
- If necessary, connect mini-USB interface cable
- Connect power supply

5.1.2 Laser Module Startup Process:

Laser module controller will follow/indicate the following process after power on:

- Setpoints for current and temperature are saved aboard the laser diode module. Upon receiving power, temperature of the laser diode will be set after a few seconds.
- The LED at the rear end indicates the unit status. There is a 20 second wait period before emission of radiation.
- Laser will operate with the saved state.



WARNING - Laser module will emit light 20 seconds after providing power.

5.2 Operation via USB Communications Port

The laser system includes complete remote-control capability through USB.

When the mini-USB cable is plugged into a PC for the first time, allow time for drivers to install. Virtual COM port (serial) drivers will install to allow the device to appear as an additional COM port. Application software can access the laser diode module similar to a standard COM port.

If computer has issues downloading or installing Virtual COM port driver, they are also available for download from FTDI: <http://www.ftdichip.com/Drivers/VCP.htm>



CAUTION – Controls do not have limit checks to validate input. Incorrect values input, could permanently damage laser diode.

Parameters as shipped are generally at maximum operating power. Setting current values above would result in premature diode death.

Warranty does not cover scenarios where improper values are input.

5.2.1 Baud rates and serial port settings

Each controller is shipped from the factory with a fixed 9600 baud, which cannot be changed.

The other serial port parameters are: 8 data bits, 1 stop bit and no parity. A hardware flow control is not supported.

5.2.2 Command formatting and termination characters

Each command to the controller must be terminated by a carriage return/line feed pair (ASCII 13 followed by ASCII 10).

All commands are case-sensitive.

Command arguments must be delimited by a single colon ':' character (ASCII 58).

5.2.3 Handshaking

Under no circumstances will the controller initiate communication. It only transmits characters in response to a message. Every message to the controller generates a response, either a numerical value or the acknowledgment string “OK”. In the event that the controller receives a message that it cannot interpret, it responds: “ERROR”. Every controller response is terminated by a carriage return/line feed pair (ASCII 13 followed by ASCII 10).

5.2.4 Commands

Items in blue are common commands that can be used.

Items that are *italics* may only work for specialized modules.

Commands	Argument	Response	Function
rli	No	**.*	Return the present operating current of the laser diode in mA
rtt	No	**.*	Return the TEC present measured temperature of laser diode in degrees Celsius
rti	No	**.*	Return the TEC present operating current in mA
stt:	**.*	OK	Set the TEC temperature in degrees Celsius (Default:25 Degree)
slc:	**.*	OK	Set ACC driver current in mA. [WARNING: Overdriving diode may cause permanent damage that are not immediately apparent.]
ton	No	OK	Enable TEC control
tof	No	OK	Shut down TEC control
rsv	No	*****	Return the laser system firmware version
rsp	No	**.*	Return the present laser setting power in mW
rst	No	**.*	Return the TEC setpoint temperature in degree Celsius
rsi	No	**.*	Return the ACC setpoint current in mA
ssc	No	OK	Save the setting to the flash memory so the laser system can operate in the same setting after repower it
rcm	No	**.*	Read the maximum laser current in mA [WARNING: This is maximum current for the module. The laser diode should not operate above it's rated power. Consequently it often means maximum current should not be used]
rsn	No	*****	Return the laser controller serial number
con	No	OK	Turn on ACC laser driver
cof	No	OK	Turn off ACC laser driver

5.3 Remote Key Switch Operation (Required for non-OEM Customers)

[VERSION 2]

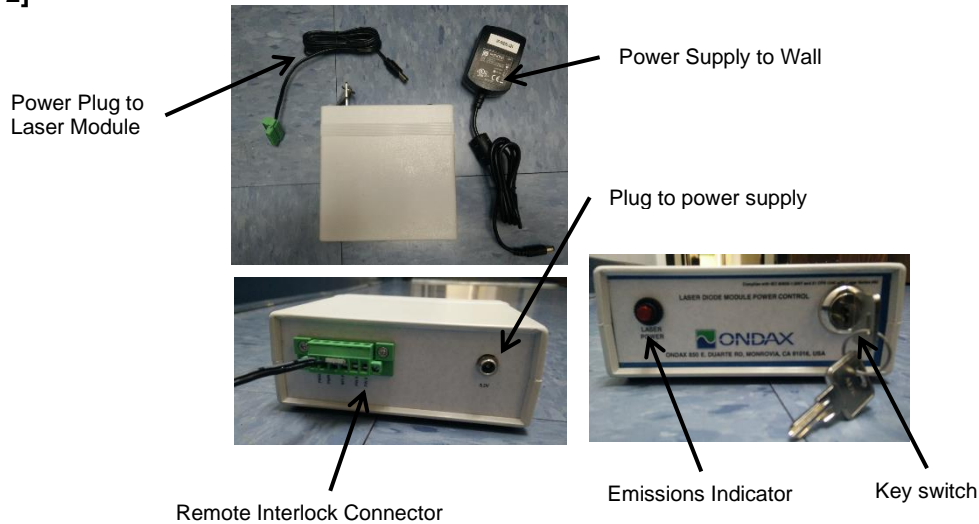

1. **Power on/off key switch**— Located on the front panel of the Remote Key Switch, this switch enables users to power the unit on with the turn of a key. The unit is inoperable when key is removed.
2. **Emission indicator**—This red LED, located to the upper right of the front panel, lights up when the unit is on to warn of eminent laser emission.
3. **Remote interlock & connector**— This feature is located on the rear panel of the Key Switch. The unit will not operate without the interlock intact. Interlock needs to be shorted for power to be available for laser diode module. A shorting bar is connected by default.

6 Maintenance

6.1 Maintenance and Inspection

Routine maintenance is not required. If the unit appears to be operating incorrectly or with low output power, check the following:

- Inspect the enclosure for scratches, dings, dents, or other signs of damage due to handling.
- Verify that the module enclosure has not been opened and the factory seal is intact.
- Verify power source connections to the laser module.
- Ensure that the operating environment is within specifications.

7 Service And Warranty

7.1 Repair

There are no user-serviceable parts inside and do not attempt to open housing. Warranty would not be valid if housing has been opened. If the module fails during use, check the items in section 5.1 before requesting an RMA.

Defective modules that are beyond the warranty period will be repaired at cost, if possible. An RMA must be requested before sending it to Coherent. When shipping, please use a box at least five times as large as the module with enough packaging material to prevent any movement of the module within the box.

7.2 For Information or Enquiries

If you need information regarding purchase or repair, or for any other Sales related questions, please contact the distributor or selling agent from whom the module was purchased.

7.3 Coherent Limited Warranty

Coherent warrants that all SureBlock™ TR-Probe THz-Raman systems will be free from defects in material and workmanship for 12 months from the date of shipment. This limited warranty covers only those defects that arise as a result of normal use of the product, and does not cover any other problems, including those that arise as a result of: (i) improper handling, maintenance or modification, (ii) operation outside the product's specifications; or (iii) unauthorized modification or misuse.

If Coherent receives, during the applicable warranty period, notice of a defect in any product which is covered by this warranty, Coherent shall either repair or replace the product, at Coherent's option. Coherent shall have no obligation to repair, replace or refund until the customer returns the defective product to Coherent. Any replacement product may be either new or like-new, provided that it has functionality at least equal to that of the product being replaced. Coherent products may contain remanufactured parts, components, or materials equivalent to new in performance.

Responsibilities of the Buyer

The Buyer is responsible for providing the appropriate utilities and an operating environment as outlined in the product literature. Damage to the system caused by failure of Buyer's utilities or failure to maintain an appropriate operating environment, is solely the responsibility of the Buyer and is specifically excluded from any warranty, warranty extension, or service agreement.

The Buyer is responsible for prompt notification to Coherent of any claims made under warranty. In no event will Coherent be responsible for warranty claims made later than seven (7) days after the expiration of warranty.

Limitations of Warranty

The foregoing warranty shall not apply to defects resulting from any of the following conditions:

- Components and accessories manufactured by companies other than Coherent, which have separate warranties
- Improper or inadequate maintenance by the Buyer
- Buyer-supplied interfacing
- Operation outside the environmental specifications of the product
- Unauthorized modification or misuse
- Improper site preparation and maintenance
- Opening the housing
- Fiber tip and fiber damage due to mishandling and cleanliness

Coherent assumes no responsibility for customer-supplied material. The obligations of Coherent are limited to repairing or replacing, without charge, equipment that proves to be defective during the warranty period. Replacement sub-assemblies may contain reconditioned parts. Repaired or replaced parts are warranted for the duration of the original warranty period only. The warranty on parts purchased after expiration of system warranty is ninety (90) days.

This warranty does not cover damage due to misuse, negligence, or accidents; or damage due to installations, repairs or adjustments not authorized specifically by Coherent.

This warranty applies only to the original purchaser at the initial installation point in the country of purchase, unless otherwise specified in the sales contract. The warranty is transferable to another location or to another customer only by special agreement, which will include additional inspection or installation at the new site. Coherent disclaims any responsibility to provide product warranty, technical or service support to a customer that acquires products from someone other than Coherent or an authorized representative.

THIS WARRANTY IS EXCLUSIVE IN LIEU OF ALL OTHER WARRANTIES, WHETHER WRITTEN, ORAL OR IMPLIED, AND DOES NOT COVER INCIDENTAL OR CONSEQUENTIAL LOSS. COHERENT SPECIFICALLY DISCLAIMS THE IMPLIED WARRANTIES OF MERCHANTABILITY AND FITNESS FOR A PARTICULAR PURPOSE.

7.4 Contacting Coherent

Coherent, Inc.
850 E. Duarte Rd.
Monrovia, CA 91016
Tel: 626-357-9600
Fax: 626-357-9321
Web: <http://www.coherent.com>
Email: customer.support@coherent.com
Technical Support: service.monrovia@coherent.com

8 Appendix

8.1 Sample communication setup using Putty

Download and install Putty, a popular open-source terminal program. Select serial once program has started:

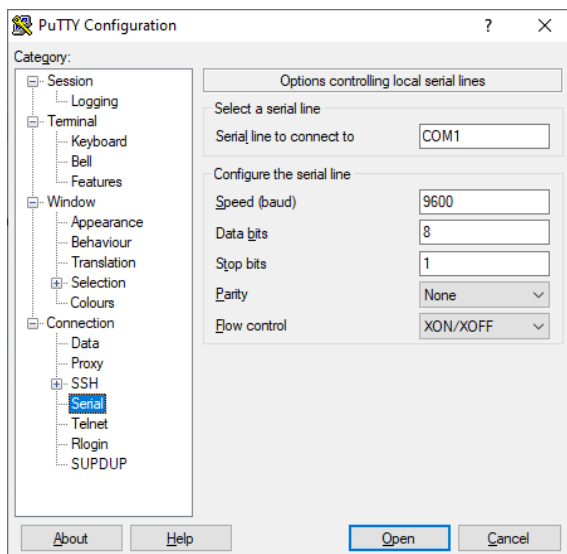

Change flow control to none

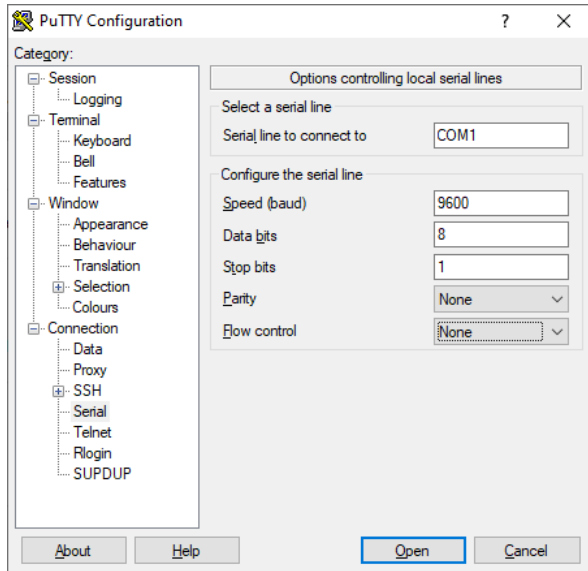

Type in appropriate serial port connected to laser

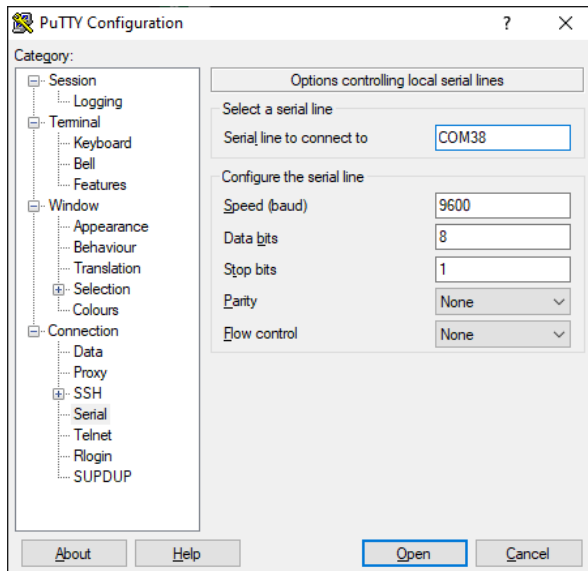

Go to Terminal and select the following:

Local Echo : Force On

Local line editing: Force Off

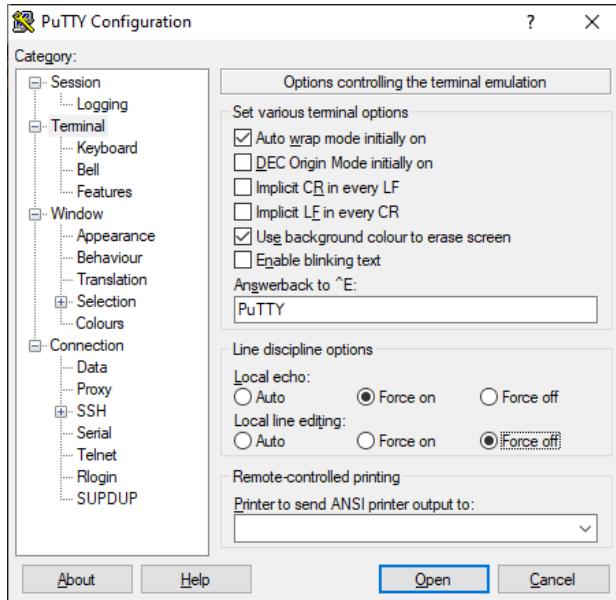

Go to Session and make sure the serial port is correct and hit Open:

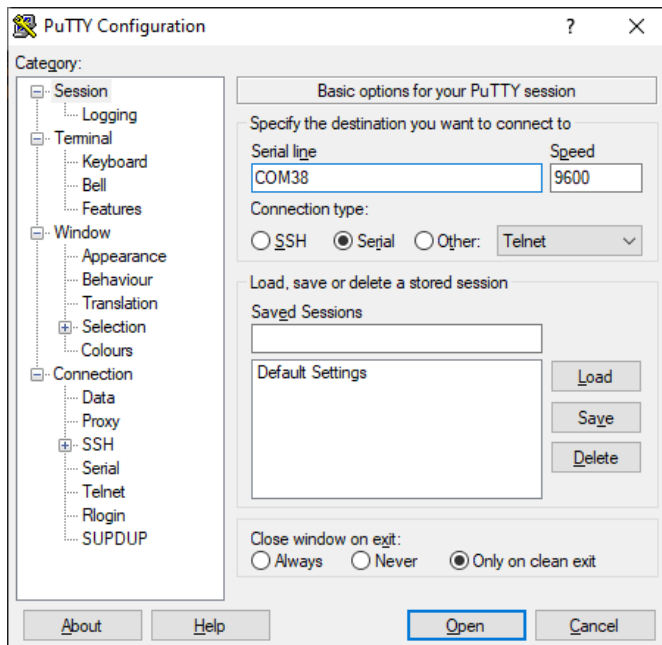

Now it looks like this:



try typing in
rtt?



followed by

Ctrl-M

Ctrl-J

Ctrl-M and Ctrl-J represents carriage return and line feed (/r/n). A response should ensue.



Sessions with Putty require the command line to be followed with Ctrl-M Ctrl J since it is the method of entering the line termination string (`\r\n`).

9 Fiber Cleaning

9.1 Importance Of Maintaining Clean Fiber-Connections

To ensure optimal performance of the laser system, it is crucial to maintain a pristine FC/PC connector on the unit and at the tips of the delivery fiber. Any contamination on the ends of the fiber connections can lead to undesirable performance outcomes and, if not addressed, may ultimately result in the failure of components or the entire system. There are also less apparent or even invisible contaminants that can cause unwanted attenuation, optical noise, or subpar performance. Examples include oils (e.g., from fingerprints), film coatings (e.g., condensates from vapors in a test chamber), and other residues (e.g., after the evaporation of water or solvents, dust, etc.). Furthermore, the laser output intensity at the very end of a fiber tip is so high that a small contaminant can be burned onto the end if it obstructs the core during operation at higher powers. This burn can damage the optical surface to the extent that it cannot be adequately cleaned, necessitating the replacement of the delivery fiber.

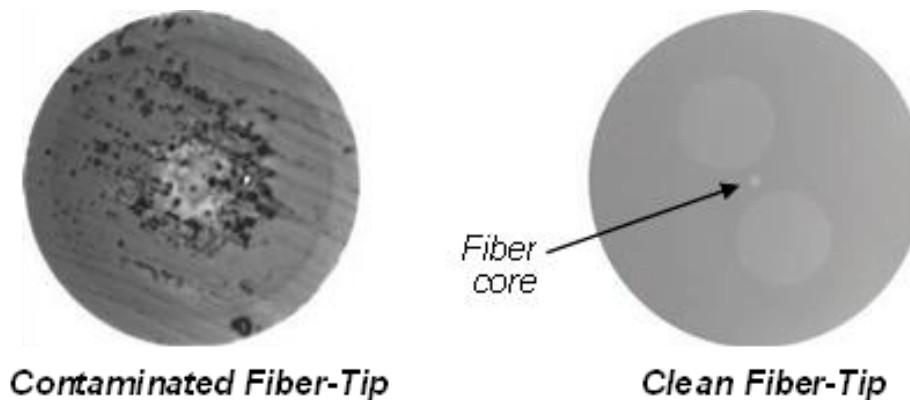

Figure 9.1-1: Contrast between a contaminated and clean Fiber-tip, as-viewed under magnification



NOTICE - When cleaning fiber components, always complete the steps carefully, and wear nitrile gloves when handling fiber-ends. NEVER touch the fiber end-face with bare fingertips, even if “clean”. The goal is to remove all dust and contamination to provide the cleanest mating surfaces possible for the optical connections. Remember that inspection, cleaning and re-inspection are very important steps which must be done before you make any fiber connections.



WARNING! – Always turn the unit OFF before you inspect a connected-fiber tip and/or clean the unit FC/PC connector:

Never look into a fiber-end or the output aperture, while the Laser Enable keyswitch is in the ON position, even if the ‘E-Stop’ and/or other safety-interlocks are open and laser emission is not occurring.

Never attempt to inspect a fiber-end with a fiberscope while the laser is ON or operating.

Never use the eyes to verify laser emission, gauge power levels, or evaluate fiber-tip cleanliness' once the laser is ON and operating.

9.2 Cleaning the Fiber Connector



NOTE - *The product recommendations presented here are provided for convenience and reference purposes only. Coherent explicitly disclaims any responsibility or implication of warranty or guarantee regarding the performance, durability, or availability of these products. Moreover, the instructions given herein are intended as general guidelines and should not be considered exhaustive or comprehensive. It is important to note that fiber-cleaning methods and recommendations may vary between manufacturers and tools. As Coherent cannot dictate the choice of cleaning products or tools a customer may select, it is strongly advised to carefully adhere to the fiber tip cleaning instructions outlined in the User Manual for each specific product.*

Coherent recommends use of either the US Conec IBC™ Brand Model 9392 (or, alternatively, Model M250) 'one-click' style FC/PC connector-cleaners each time before freshly-mating a new delivery-fiber to the unit



Figure 9.2-1: US Conec IBC™ Brand Model 9392 and M250 FC-connector cleaning tools



NOTICE - *No known cleaning method is absolutely 100% effective. Thus, it is imperative that inspection is included as an 'integral part' of your cleaning process and protocol. Incorrect cleaning can damage the fiber, and/or the laser internally.*

9.3 Inspecting And Cleaning Delivery-Fiber Ends

Inspection of delivery-fiber ends are done with either a desktop video-fiberscope or a hand-held fiberscope. Both tools are specialized microscopes used for inspecting optical fibers. Any scope chosen should provide

at least 200x total magnification. **Specific adapters may be needed for FC/PC connectors** to properly inspect the Fiber-tip. Figure 9.3-1 provides examples of popular scopes.



Handheld Fiber-Optic Inspection Scope

Desktop Video-Microscope Fiber Inspection Scope

Fiber-Optic Inspection-Scope Adapters



E-2000 Service Adapter 1019034 to hold spring loaded cap open

Figure 9.3-1: Examples of Fiber-tip inspection scopes and tools

To inspect a delivery-fiber tip:

1. Make certain that the laser is turned OFF before starting inspection.
2. Put the applicable inspection adapter or probe on your equipment.
3. Unscrew and remove the delivery-fibers' dust cap.
4. Insert the delivery-fiber connector into the fiberscope adapter and adjust the focus ring until you see a clear fiber tip image.
5. Clean the fiber tip and re-inspect, as necessary. See below for an overview on fiber tip cleaning.
6. Immediately plug the clean connector into the connector it will be mating-to decrease the risk of re-contamination.

Dry Cleaning Technique

The recommended dry-cleaning technique utilizes a 'cartridge' cleaning tool. Coherent recommends use of the following cartridge cleaning tools and associated techniques. (source-websites, valid as-of the time of this writing).

Figure 9.3-2 shows examples of these tools



OPTIPOP R, P/N ATC-RE-02

<http://www.ntt-at.com/product/optipop/>



CLETOP-S TYPE A, P/N 14110501

<http://www.cleto.com/html/products.html>

Figure 9.3-2: Examples of recommended Cartridge Fiber-tip cleaning tools



NOTE— Since fiber-cleaning techniques and advice can vary from manufacturer-to-manufacturer (and tool-to-tool), and Coherent cannot 'control' what cleaning product or tool a customer may choose to purchase, it is simply recommended to closely follow the Fiber-tip cleaning instructions provided in each products' User Manual.

Wet Cleaning Technique

1. Make certain that the laser is turned OFF before starting cleaning.
2. Carefully remove the delivery-fibers' dust cap.
3. Inspect the fiber-tips with a fiberscope. (See Figure 9.2-1, above)
4. If a tip is dirty, clean with a cartridge cleaner, as-per the manufacturer's instructions – or – follow a simple 'Wet-to-Dry wipe' technique, as-follows: (Also see Figure 9.3-3, below)



CAUTION – Follow all safety instructions when using isopropyl alcohol and/or methanol (used for wet cleaning of the fiber tip). If you do not have a copy of the safety instructions and MSDS sheets for using IPA or methanol, contact your Industrial Safety Dept. before following the cleaning information described in this document.

1. Start with a fresh sheet of lint-free, optical-grade lens paper, folded 3 times, to yield a cleaning surface with '8 layers' of folded material. Be
2. careful not to touch or contaminate this cleaning 'pad'.
3. Carefully drop spectroscopic-grade isopropyl alcohol ('IPA') or methanol onto the pad, until the 'wet area' is approximately the size of a penny.
4. Ensure that an area of the cleaning pad remains dry.

5. Place the 'pad' just created on a clean, smooth work-surface, and bring the fiber tip to a perpendicular-angle to the pad, and lightly contact it against the surface of the pad.
6. With very light pressure, and holding the tip to the cloth, 'wipe' the fiber tip lightly across the Wet area of the pad, using a 'scalloped Figure 8' motion. Do Not 'scrub' back and forth! At the same time, gently rotate the fiber-tip 90 – 180 degrees, maximum.
7. Immediately repeat this same action on a clean, dry-section of the pad to remove any traces of solvent. Again, Do Not 'scrub' back and forth!



NOTICE - *Improper 'Wet' techniques can complicate fiber tip cleaning and should only be used when all dry, 'cartridge-tool based' techniques have failed to clean the tip sufficiently. The primary concern with using solvents is if it is not removed completely from the tip, residual liquid acts as a transport mechanism for loose debris elsewhere on the end-face. If the solvent is simply allowed to evaporate slowly off the end, it can leave residual contaminant on the fiber core. This is extremely difficult to clean off without another Wet cleaning and usually more difficult to remove than the original contaminant. Excess solvent can also remain in tiny 'surface-pits' where it can re-emerge upon fiber connection.*

Additionally, 'scrubbing' the fiber back-and-forth on the pad or wiping over the same area more than once can re-contaminate or damage the Fiber-tip.

(See technique-steps illustrated in Figure 9.3-3, next-page)

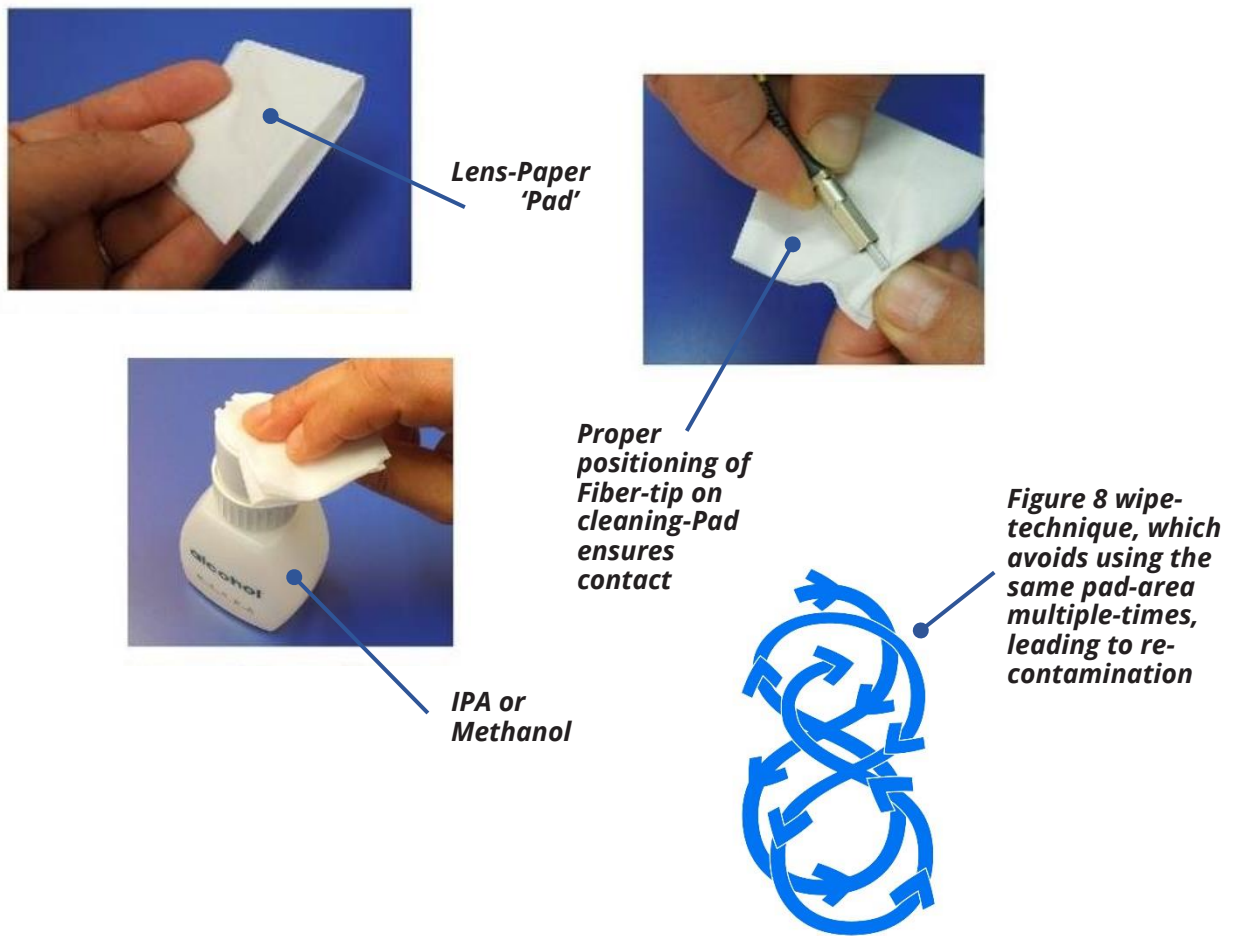

Figure 9.3-3: 'Figure 8' Wet-cleaning a fiber-tip with a 'cleaning pad' made from optical-grade lens paper.

Summary:

1. Inspect the delivery-fiber tip with a fiberscope or microscope, as per the instructions above. If the tip is dirty, use the Dry-cleaning technique to clean it, as-per the instructions above.
2. Re-inspect the fiber tip. If the connector is still dirty, repeat the Dry-cleaning technique, as-per above, a second time.
3. Re-inspect the fiber tip again. If the connector is *still* contaminated, clean it with the Wet cleaning technique, as per the instructions above.
4. Re-inspect the fiber tip again. If the contaminate is still present, repeat the Wet cleaning process, as per above, until the fiber tip is clean.

If the delivery-fiber tip is *still* contaminated after several cleaning attempts using both the Dry and Wet cleaning techniques, contact your technical support

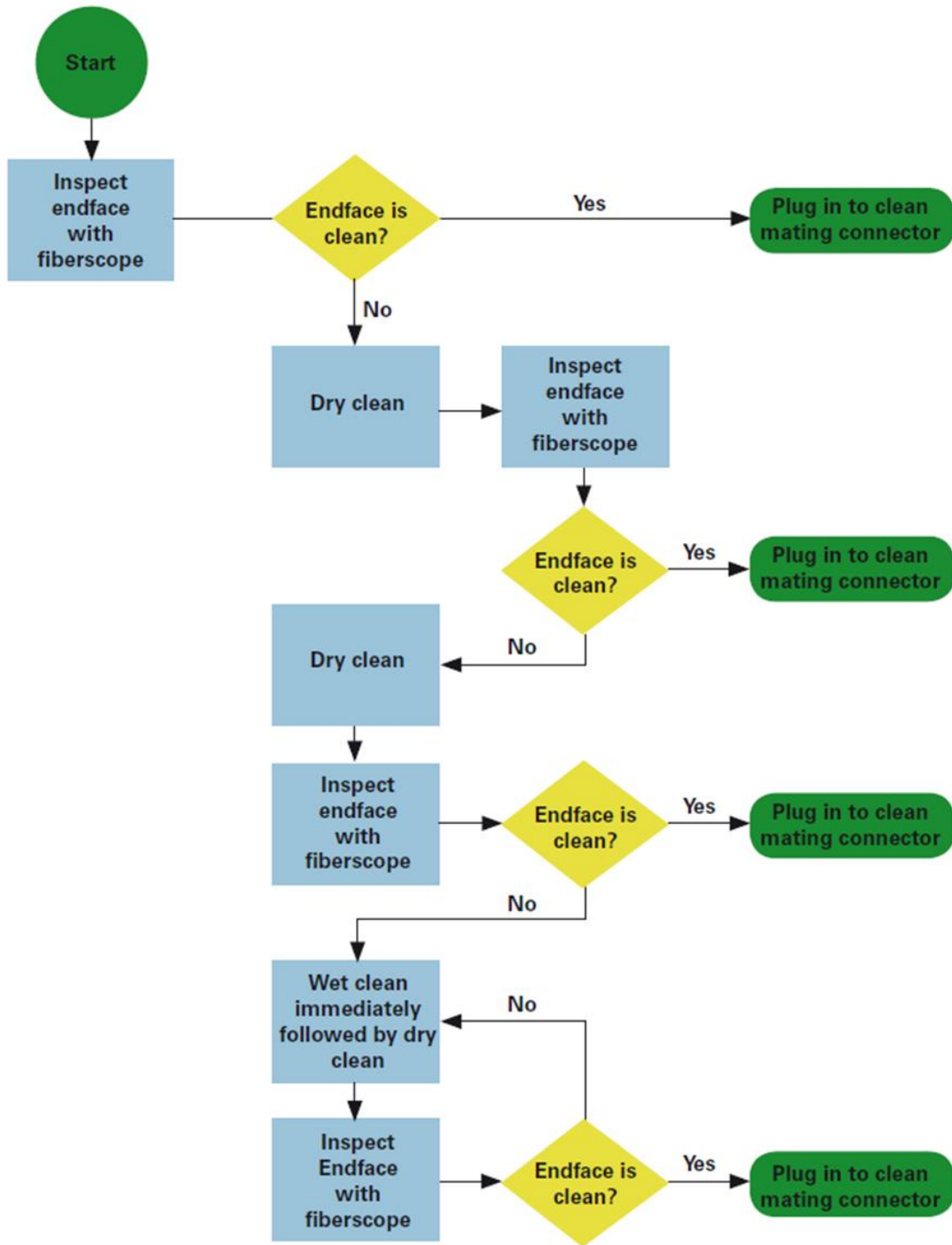

Figure 9.3-4: An example of a fiber cleaning process flow



INNOVATIONS THAT RESONATE